

HHN-RA1

Signal Relay Module
信号继电器模块

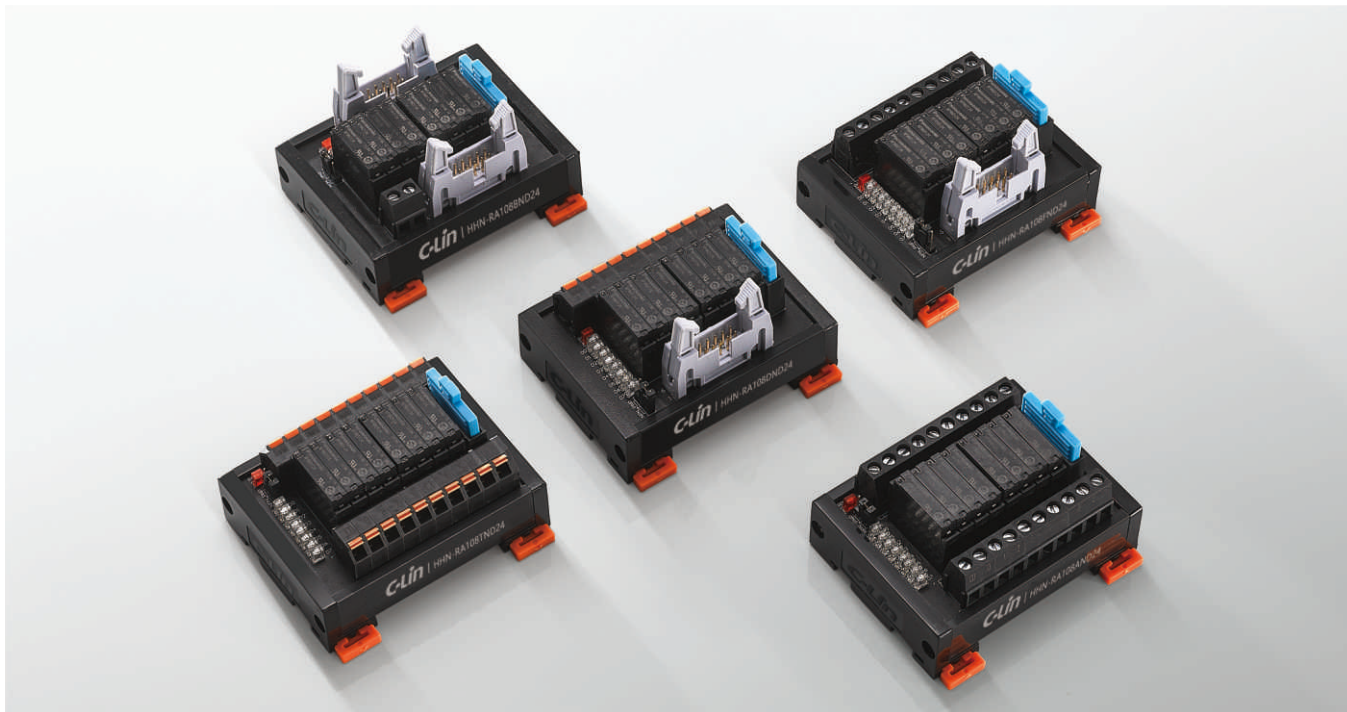

产品特点 FEATURES

- 输入/输出侧带浪涌吸收回路，可有效延长继电器触点的寿命，并可减缓负载侧的瞬间冲击电流；
- NPN/PNP双极性输入对应，并且指示灯也会跟随输入信号的不同而亮不同颜色，绿色-NPN，红色-PNP；
- 输入侧接错线保护。
- The input/output side is equipped with surge absorption circuit, which can effectively prolong the service life of relay contacts and slow down the instantaneous impulse current at load side
- NPN/PNP bipolar input is compatible, and the indicator light will also light up in different colors according to the input signal, green-NPN, red-PNP;
- Wrong line protection at input side

适用范围 APPLICATION

适用于三菱、西门子、欧姆龙、松下等各类PLC。
Applicable to Mitsubishi, Siemens, Omron, Panasonic and other PLC.

关联产品 RELATED PRODUCTS

APAN3124 继电器 Relay

HHN-RA1系列信号继电器模块底座
HHN-RA1 Series Signal Relay Module Holder



APAN3124



HHN-RA1 □□□□ Z

输入线圈参数 INPUT COIL PARAMETERS

• 额定电压 Rated voltage	5VDC/12VDC/24VDC
• 额定电流 Rated current	7.5mA, 8.3mA
• 动作电压 Action voltage	75%以上(常温环境)
• 释放电压 Release voltage	5%以下(常温环境)
• 动作时间 Action time	20ms以下
• 释放时间 Release time	10ms以下
• 接触电阻 Contact resistance	30mΩ以下(DC6V 1A) 100mΩ以下(DC6V 1A)
• 绝缘阻抗 Insulation resistance	1000mΩ (500VDC)

输出触点参数 OUTPUT CONTACT PARAMETERS

• 触点材质 Contact material	银合金 Silver Alloy
• 电气性能 Electrical Performance	5A/250VAC、5A/30VDC
• 机械耐久性 Mechanical durability	5000000次
• 使用环境温度 Operating ambient temperature	-40-85°C(无结冰、无凝霜)
• 使用环境湿度 Operating ambient humidity	20~85%

适合电线 SUITABLE WIRE

剥线长度: 6mm 1.5mm² Following /AWG16



HHN-RA1

Signal Relay Module
信号继电器模块



型号解析 MODEL ANALYSIS

HHN	-	R	A1	04	A	N	D24	/	***
品牌 Brand		继电器类型 Relay type	设计序列号 Design serial number	继电器控制单元数量 Number of relay control bit	输入/输出端口类型 Input/output port type	输出端保护方式 Output protection mode	工作电压 Working voltage		配置继电器品牌或其他 Configure relay brand or other
HHC 继电器模块 HHC Relay module		R 电磁继电器 Electromagnetic relay	A 信号继电器 Signal relay A1 50mm宽度信号继电器模块 50mm signal relay module	02 2位 2 Bit 04 4位 4 Bit 06 6位 6 Bit 08 8位 8 Bit	A 螺钉式接线端子 Screw terminal B MIL连接器 MIL connector T T型弹片式接线端子 T Type Shrapnel terminal C B+A组合 B+A combination D B+T组合 B+T combination F A+B组合 A+B combination G T+B组合 T+B combination	N 无保护 Unprotected C 浪涌抑制 Surge suppression	D5 5VDC D12 12VDC D24 24VDC		PAN 松下 Panasonic OMR 欧姆龙 Omron TYC 泰科 Tyco HF 宏发 Hongfa G 出线共线 Outgoing collinear

注: 无继电器配置的继电器模块座命名: 在工作电压后增加Z
Note: name of relay module base without relay configuration: Z after working voltage



产品图展示 PRODUCT DISPLAY

配线图及外形图 Wiring Diagram and Dimensions

HHN-RA104C/D

HHN-RA104CCD24
HHN-RA104CND24



外形尺寸图 Dimensions

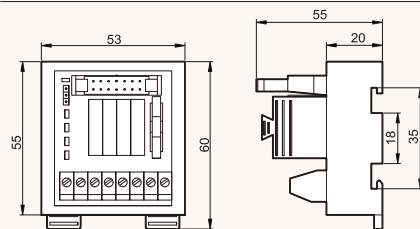

配线图 Wiring Diagram

HHN-RA104DND24
HHN-RA104CND24



HHN-RA104DND24
HHN-RA104CND24

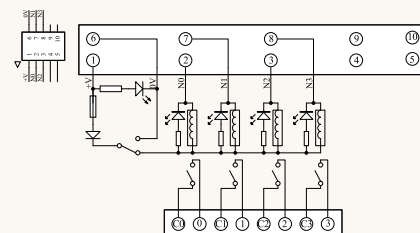

HHN-RA104DCD24
HHN-RA104CCD24

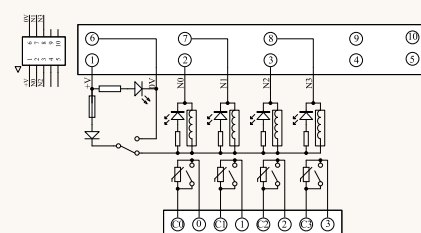

HHN-RA1

Signal Relay Module
信号继电器模块

配线图及外形图 Wiring Diagram and Dimensions

HHN-RA104A/T

(mm)

HHN-RA104AND24
HHN-RA104ACD24



外形尺寸图 Dimensions

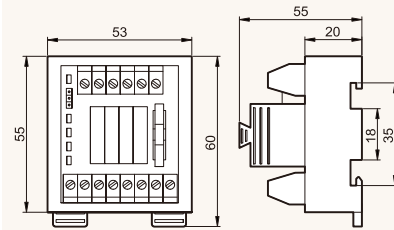

HHN-RA104TND24
HHN-RA104TCD24



配线图 Wiring Diagram

HHN-RA104AND24
HHN-RA104TND24

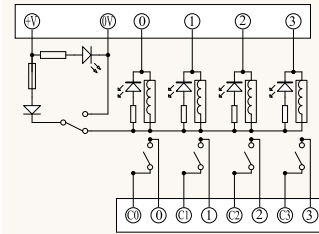

HHN-RA104ACD24
HHN-RA104TCD24

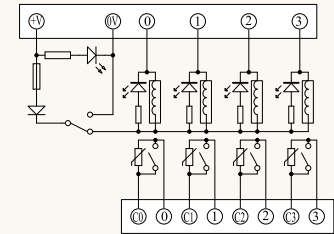

HHN-RA108A/T

HHN-RA108AND24/G4
HHN-RA108AND24/G8
HHN-RA108ACD24/G4

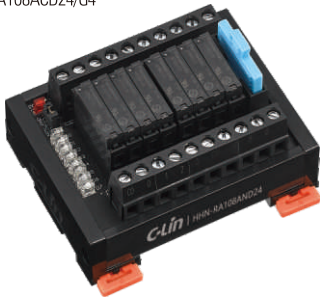

外形尺寸图 Dimensions

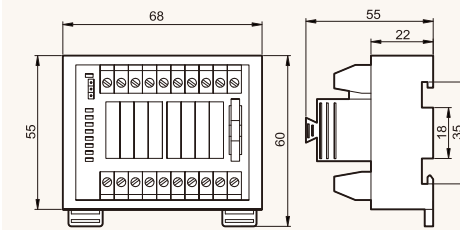

HHN-RA108TND24/G4
HHN-RA108TND24/G8
HHN-RA108TCD24/G4



配线图 Wiring Diagram

HHN-RA108AND24/G4
HHN-RA108TND24/G4

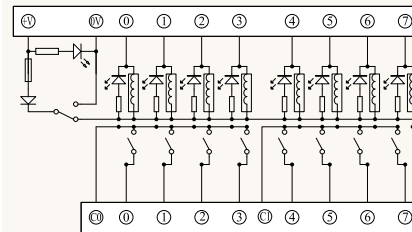

HHN-RA108AND24/G8
HHN-RA108TND24/G8

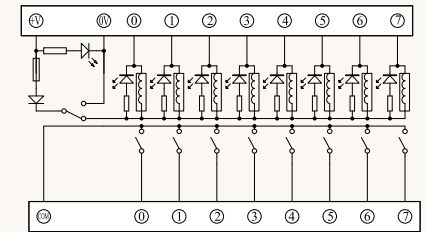

HHN-RA108ACD24/G4
HHN-RA108TCD24/G4

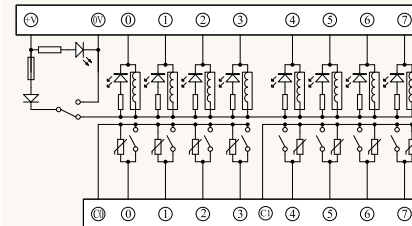

如要求这款出线带普通二极管保护，属于特殊型号，型号为RA108ADD24/G8

HHN-RA1

Signal Relay Module
信号继电器模块

配线图及外形图 Wiring Diagram and Dimensions

HHN-RA108F/G

(mm)

HHN-RA108FND24/G8
HHN-RA108FCD24/G8



外形尺寸图 Dimensions

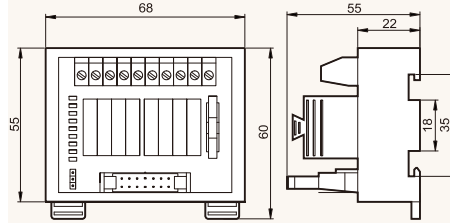

HHN-RA108GND24/G8
HHN-RA108GCD24/G8



配线图 Wiring Diagram

HHN-RA108FND24/G8
HHN-RA108GND24/G8

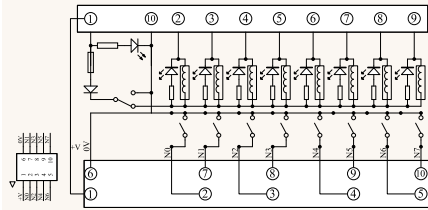

HHN-RA108FCD24/G8
HHN-RA108GCD24/G8

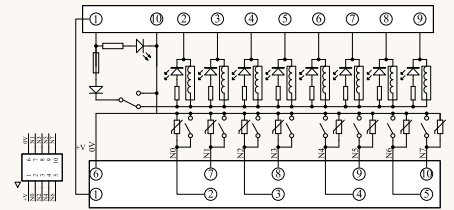

HHN-RA108C/D

HHN-RA108CND24/G4
HHN-RA108CCD24/G4



外形尺寸图 Dimensions

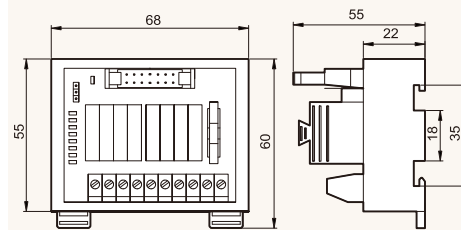

HHN-RA108DND24/G4
HHN-RA108DCCD24/G4



配线图 Wiring Diagram

HHN-RA108CND24/G4
HHN-RA108DND24/G4

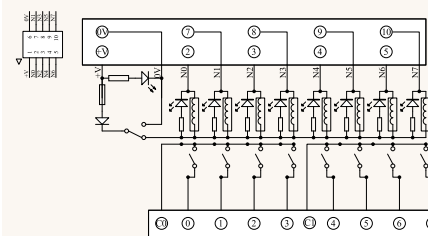

HHN-RA108CCD24/G4
HHN-RA108DCCD24/G4

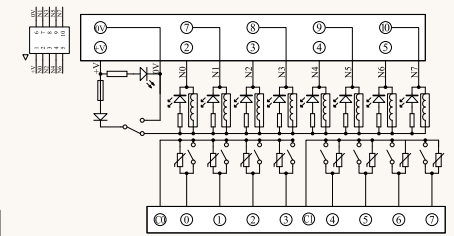

HHN-RA1

Signal Relay Module
信号继电器模块

配线图及外形图 Wiring Diagram and Dimensions

HHN-RA108B

(mm)

HHN-RA108BND24/G8
HHN-RA108BCD24/G8



外形尺寸图 Dimensions

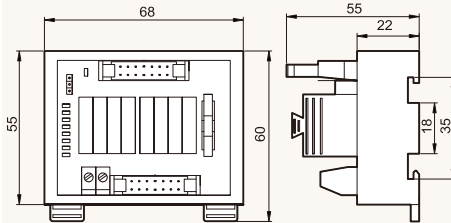

配线图 Wiring Diagram

HHN-RA108BND24/G8

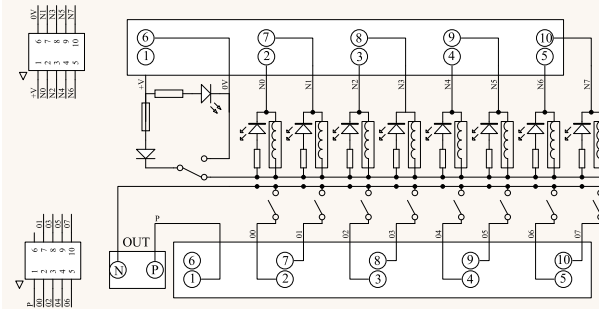

HHN-RA108BCD24/G8

